

# DVI Parrot

Featuring  
**Parrot Trainer** software



The EDID Emulator by



- Unique new accessory for the video professional. Allows user-configurable EDID management.
- Precise analysis and/or control of all EDID parameters via USB. "Trainer" software included – Mac or Windows.
- Standard EDID library supplied or the user can capture and edit, or create their own EDID profiles from scratch.
- Profiles can be permanently saved as computer files which can be copied, emailed, archived, etc.
- Libraries can be imported and exported to share and manage EDID settings.
- Trainer software supports multiple Parrots for devices with multiple outputs.
- Accessible Mode button and RGB Status LED provide basic hardware control.
- Dual-link DVI-I compatible for both high bandwidth digital and analog functionality.
- DVI powered for spoofing & capture, USB powered for "training" – no additional PSU required.
- Compatible with VESA EDID 1.3 and EDID Extensions EIA/CEA-861 (HDTV support etc.).
- Rugged, compact device – only 1.1 inch cable insertion / panel depth.
- Elegant and cost-effective solution for the real-world challenges faced by today's video technicians.

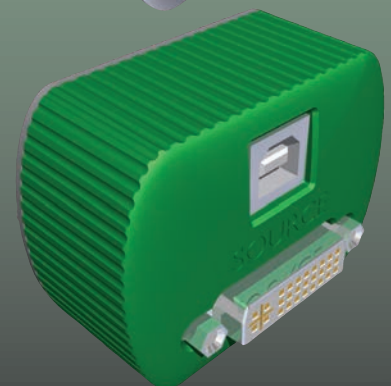
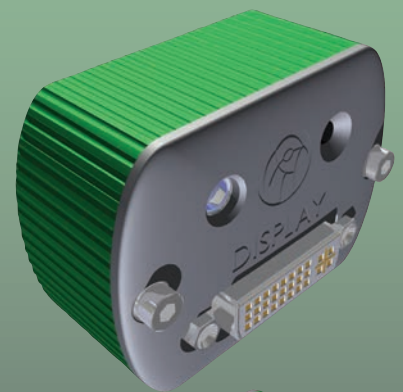
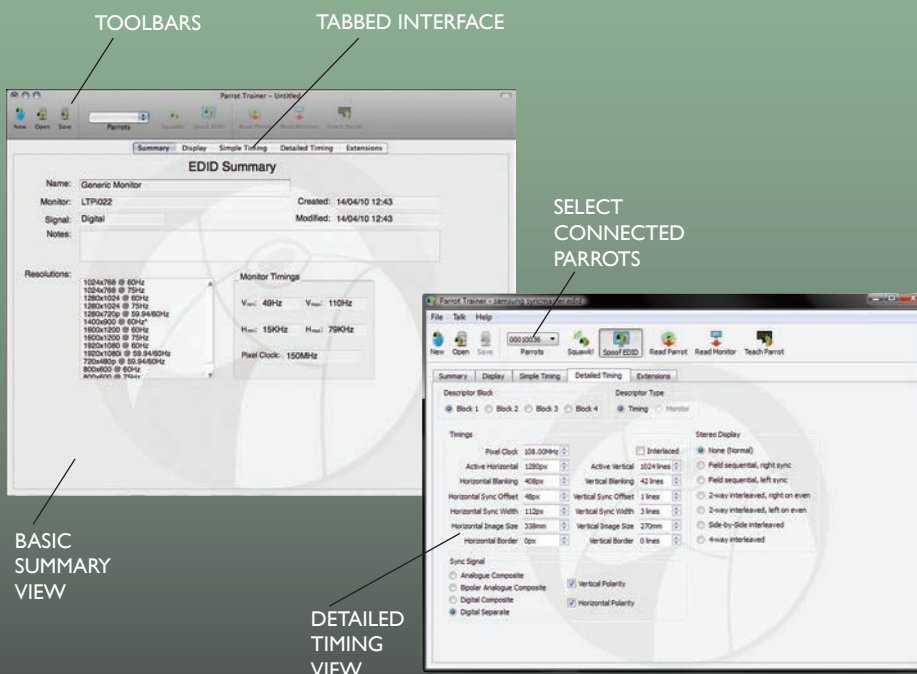

Exclusively Distributed by TMB

Innovative, Performance-Driven Show Technology Since 1983

tmb.com

Los Angeles

London

New York

Beijing

Toronto

+1 818-899-8818

+44 (0)20-8574-9700

+1 201-896-8600

+86 10-8492-1587

+1 519-538-0888



# DVI Parrot

Dimensions in  
Inches [mm]

USB CONFIGURATION

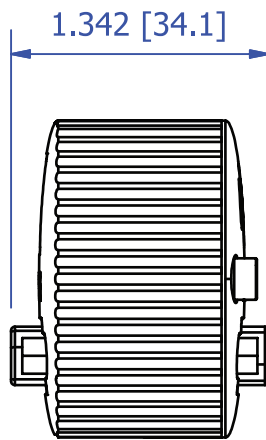
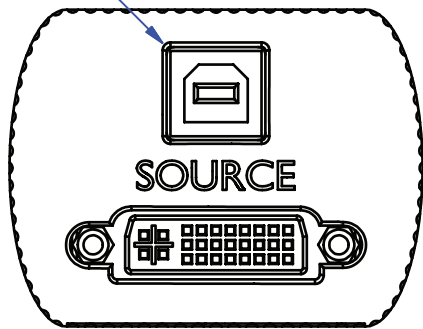

RGB STATUS LED

MODE SWITCH

2.150 [54.6]

1.650 [41.9]

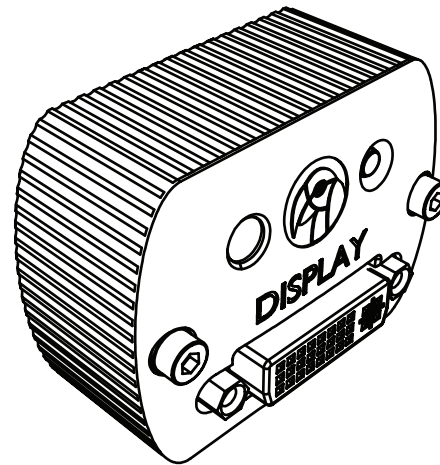
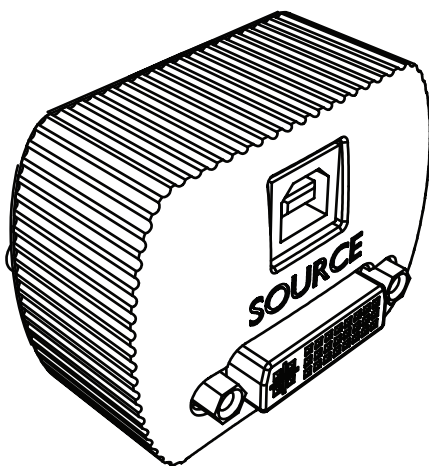
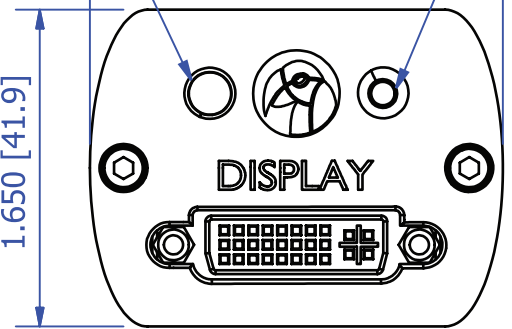

1.096 [27.8]  
CABLE INSERTION  
/ PANEL DEPTH

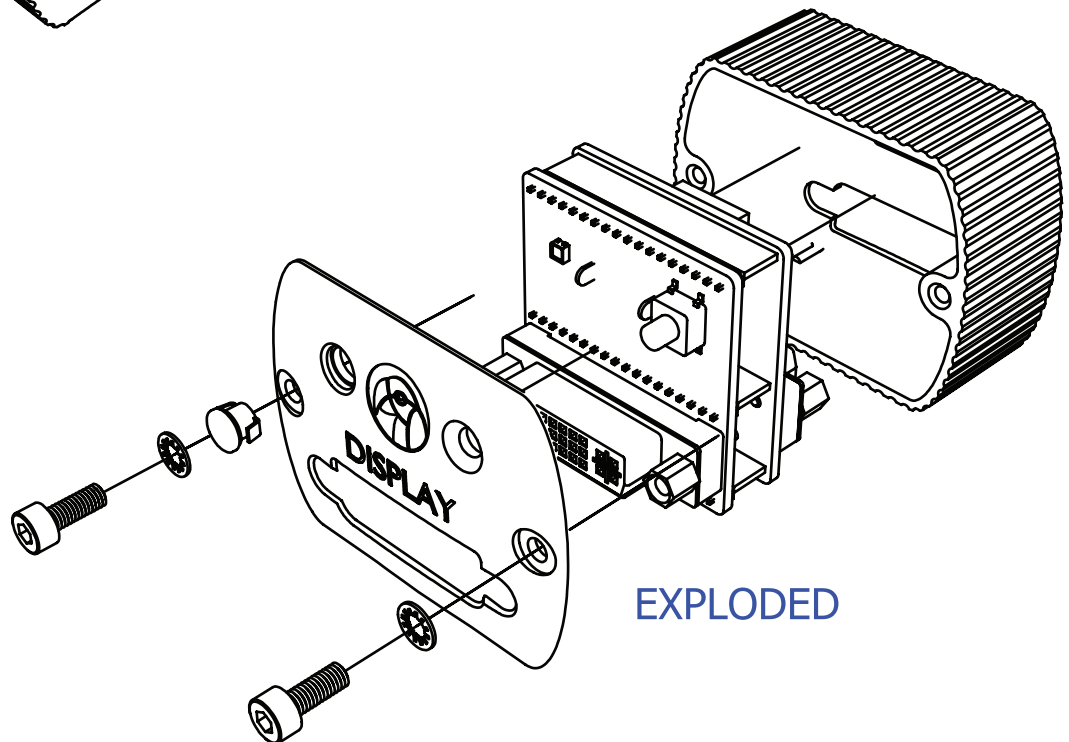
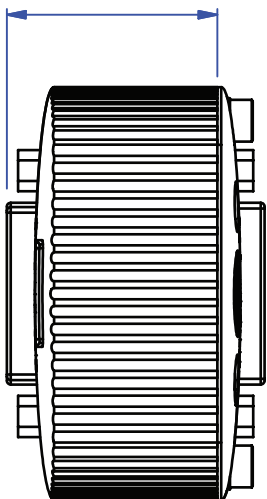

EXPLODED